

Griffe/ Pull handles

PH 101

BN

Glasbohrung/
Glasshole: 16 mm

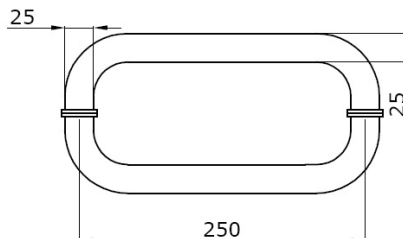

PH 102

BN

Glasbohrung/
Glasshole: 16 mm

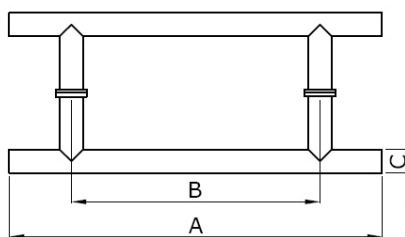
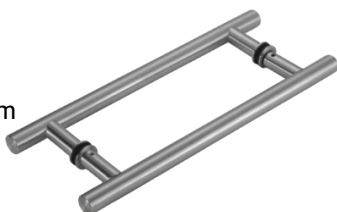

	in mm		
	A	B	C
PH 102-350	350	250	Ø 25
PH 102-720	720	620	Ø 25
PH 102-1000	1000	600	Ø 32
PH 102-1760	1760	520	Ø 25

→ 4 Glaskonsolen

PH 103

BN

Glasbohrung/
Glasshole: 16 mm

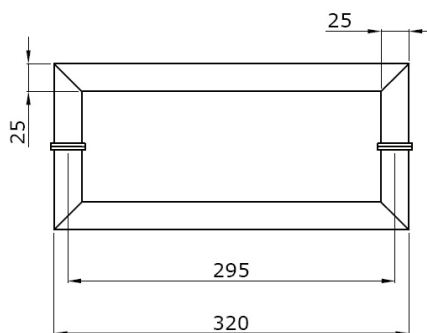
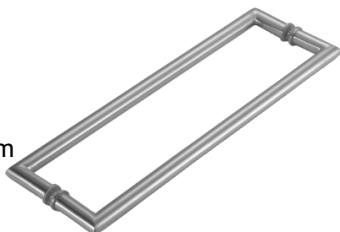

PH 104

BN

Glasbohrung/
Glasshole: 12 mm

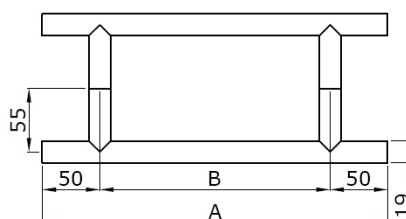
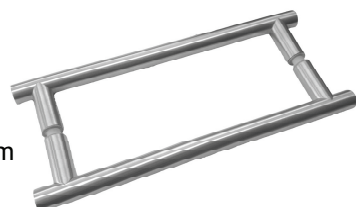

	in mm	
	A	B
PH 104-300	300	200
PH 104-450	450	350
PH 104-600	600	500



SP 701

PC BN

Glasbohrung/
Glasshole: 14 mm

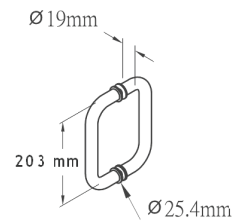

TB 702

PC BN

Glasbohrung/
Glasshole: 14 mm

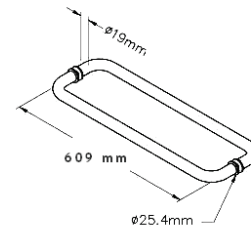

SP 800

L = 610 mm

BN

L = 305 mm

PC BN

Glasbohrung/
Glasshole: 10 mm

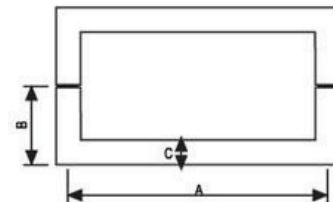

	in mm		
	A	B	C
SP 800 - 305	305	60	19x19
SP 800 - 610	610	60	19x19

PH 102-720

BL

Glasbohrung/
Glasshole: 16 mm

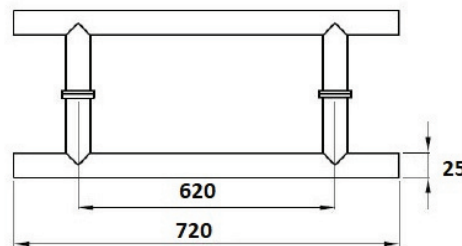

PH 104-400

BL

Glasbohrung/
Glasshole: 12 mm

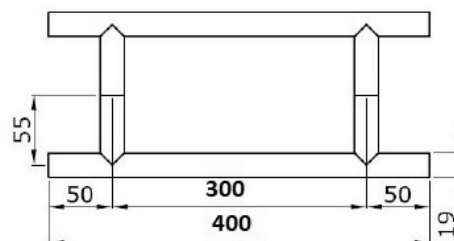

Versperrbare Griffe/ Lockable handles

PHL 1200B

BN

beidseitig sperrbar,
inkl. 1 Bodenbuchse

Ausladung 88 mm

vorgerichtet für
Profil-Zylinder 160/30 mm

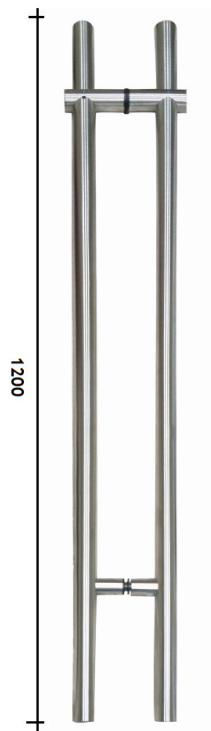

Glass Cut Out

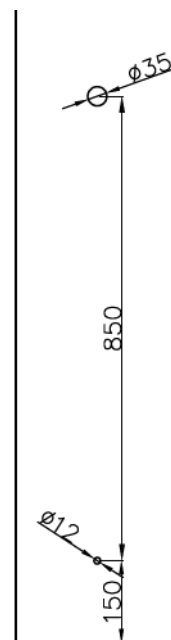

2

PHL 1200S

BN

einseitig sperrbar,
für Profil-Halb-Zylinder

inkl. 1 Bodenbuchse

Ausladung 78 mm

vorgerichtet für
Profil-Halb-Zylinder
10/30 mm

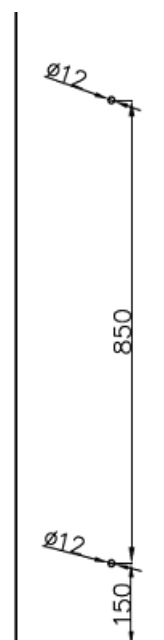
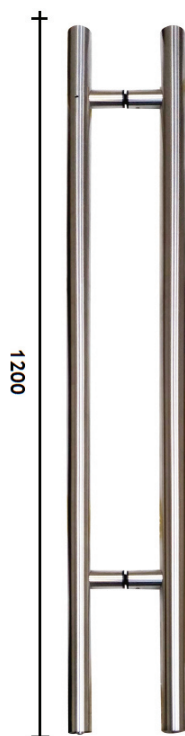

PHL 1300B

BN

beidseitig sperrbar,
inkl. 1 Bodenbuchse

Ausladung 88 mm

vorgerichtet für
Profil-Zylinder 80/30 mm

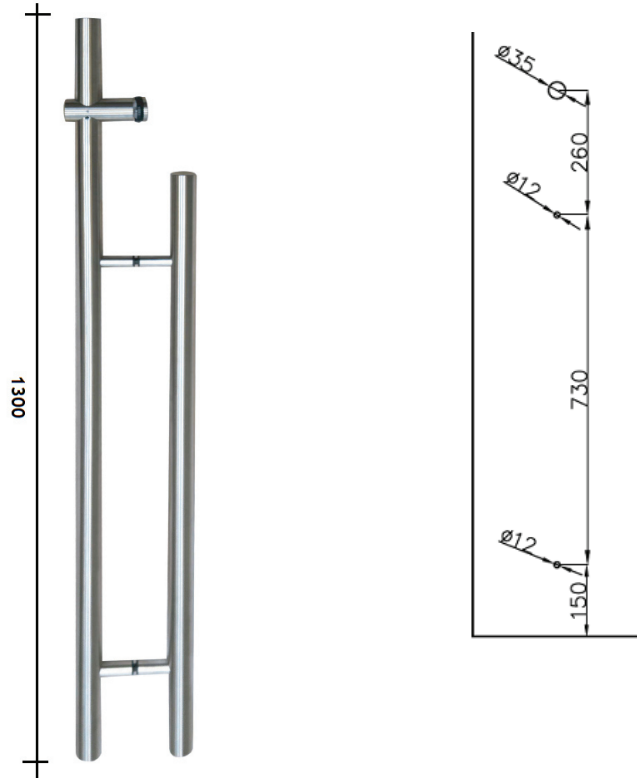

PC 160/30

BN

Profil-Zylinder 160/30 mm,
verschiedenschließend

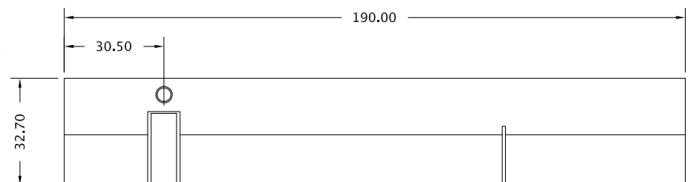

PC 10/30

BN

Profil-Zylinder 10/30 mm,
verschiedenschließend

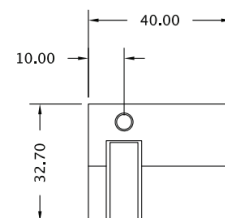

PC 80/30

BN

Profil-Zylinder 80/30 mm,
verschiedenschließend

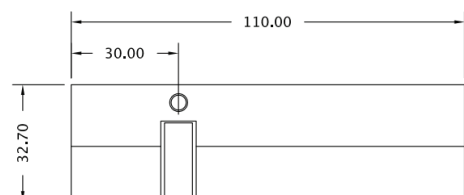

Türstopper/ Door stopper

H 362X

BN



CY 805

BN



2

